



More Precision

opto**CONTROL** CLS1000 // Fiber optic sensor for industrial applications



Fiber optic sensors optoCONTROL CFS

 All sensors can be customized.
 We would be pleased to manufacture your sensor according to your drawing.
 Please contact us directly for more information!

Examples of customer-specific modifications

Function

- Special types for transmission sensor CFS3
- Special types for CFS4 reflex sensor

Optical fiber sheath

- Silicone-metal sheath
- VA stainless-steel sheath
- Metal sheath
- PVC metal sheath
- PVC special sheath
- BOA special sheath
- MA-radius-limiting special sheath

Fiber bundle diameter

- 0.6 / 1 / 1.5 / 2.5 / 3 mm

Optical fiber (length)

- Available from 300 mm
- Standard length 1,200 mm
- 600, 1,800 and 2,400 mm optionally available
- Individual length from 0.3 to 2.4 m possible

Aperture angle

- Standard 67°
- Optional 22° / 35°

Ambient conditions

- Special versions with increased vibration resistance (VS)
- Special variants with special bonding for high temperatures (250 °C / 400 °C)
- Pressure-tight special variants with vacuum feedthrough (up to 10⁻⁵ mbar)

Sensor heads

- Straight sensor heads with a viewing direction of 0 degree
- 90° output for confined installation spaces
- Sensor head with wide light band (possible width between 3 and 88 mm)
- Sensor heads with and without external thread
- Thin sensor heads with bendable head
- Sensor heads in angular arrangement (CFS1)

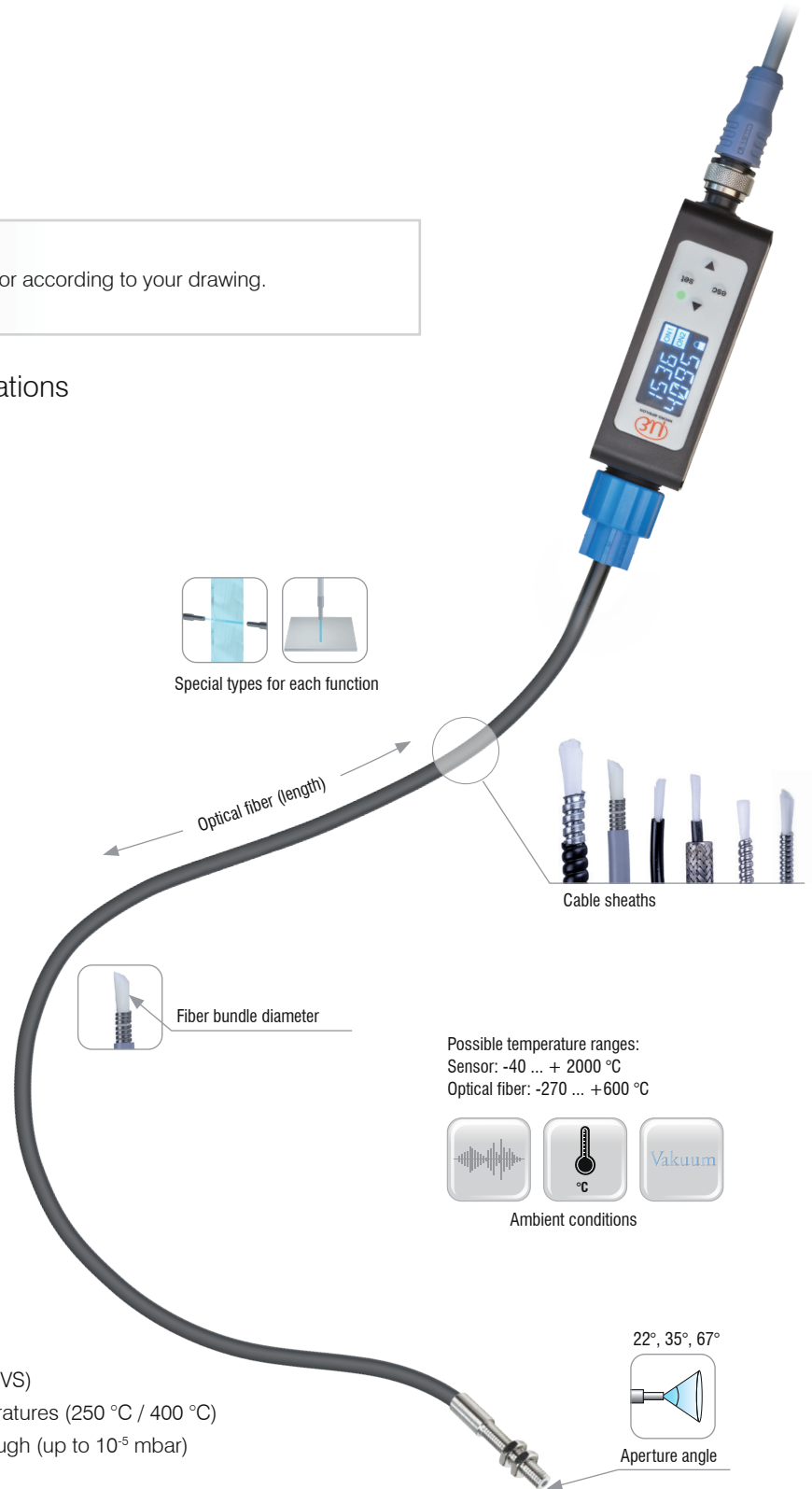

Notes on the function of the CFS sensors

Application instructions on selecting the appropriate function.

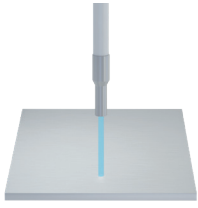

Reflex sensor (one-way system)

- Detection range max. 1200 mm
- Quick and easy installation
- Detection of the finest structures
- Presence detection
- Ideal for level monitoring, position and location determination

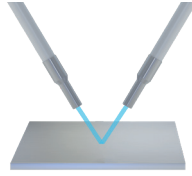

Reflex mode V-arrangement (two-way system)

- Detection range max. 1200 mm
- Very exact positioning of the switching point
- Two objects generate highest intensity on the intersection
- Suitable for light dust and particles flying in the path of the beam
- Gloss detection

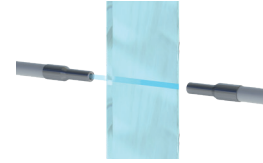

Transmission mode (two-way system)

- Large distance between receiving and transmission unit up to 2000 mm
- Objects are detected by interruption of light beam
- Arbitrary point of light transmission
- Detection of transparent objects
- Ideal for part recognition, counting tasks, edge detection, presence monitoring

Vacuum suitability

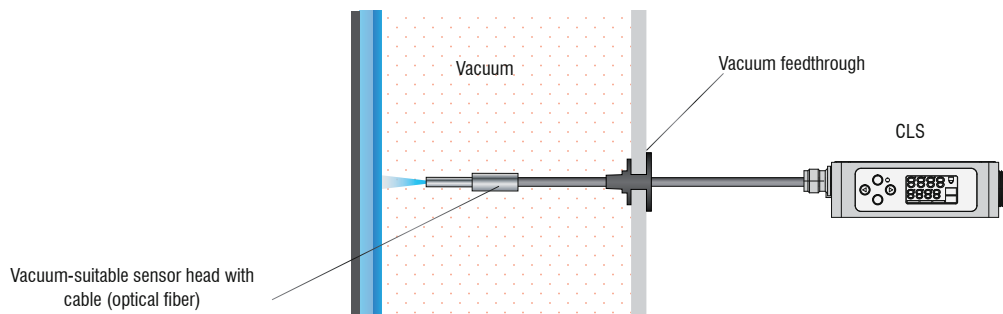





The fiber optic sensors and fiber optic cables are built with passive components and do not emit heat to the environment.

In vacuum, sensors (temperature bonding T250), optical fibers (stainless steel sheath), and the vacuum feedthrough up to 10^{-5} mbar can be used.

Transmission sensor for transparent/translucent objects

optoCONTROL CFS3

-  Large operating range between receiver and transmitter unit with up to 2000 mm
-  No exact positioning of the measuring object necessary
-  Simple and space-saving mounting
-  Models with and without external thread

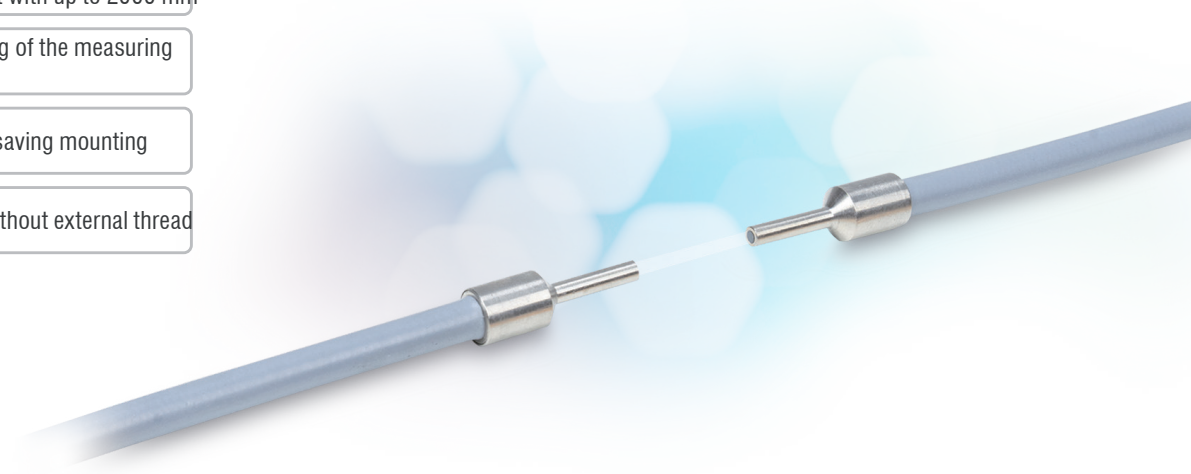

With the transmission sensor, the infrared light emitted by the controller is guided via the optical fiber to the transmitter and from there to the detecting object. There, the light beam is either interrupted or transmitted, depending on the target. The receiving unit of the sensor receives the remaining light and sends it back to the controller via the optical fiber. The remaining light component consists of either the unshielded light component or light transmitted from the object. By illuminating the transmitter through the object, it is possible to detect levels of liquids in jars as well as transparent objects. In addition to detecting transparent and semi-transparent objects, the sensor arrangement of the transmission sensor in transmitted light (180:0) is ideally suited for area detection, as a light barrier, for distinguishing sizes and diameters, for tolerance inspection and for web edge detection.

The CFS3 sensors, in combination with the performance of the CLS1000 series, provide reliable results. Here, the distance variation between the test specimen and receiver or illumination has no noticeable influence on the result. The transmission sensor can be universally used but is also suitable for special solutions (customer-specific adaptations).

The sensors are available with different operating ranges, temperature ranges and lengths. This enables a wide range of applications. The fiber optic cable has a sensor head, which is available in different versions:

With external thread: For example, threaded sensors can be easily fixed on a mounting bracket.

Without external thread: Cylindrical sensor heads are suitable for space-saving mounting. This is achieved by simply setting a grub screw.

Measurement geometry:

Transmission sensor 0°:180°

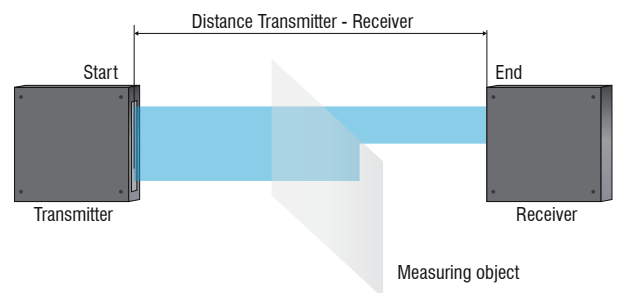
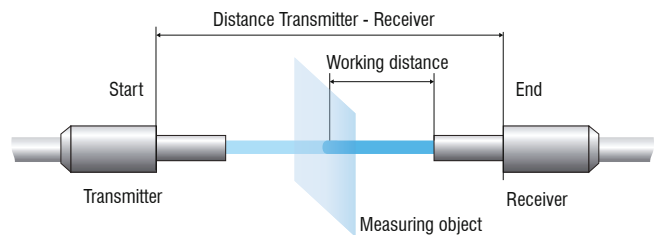

Transmission sensor with transmitter and receiver

90° deflection: If the installation depth and the mounting space are very limited, sensors with integrated 90° deflection are the optimal solution.

Flat sensor head: Thanks to the light band, flat sensor heads are ideal for distinguishing sizes and diameters, monitoring web edges, and area detection.

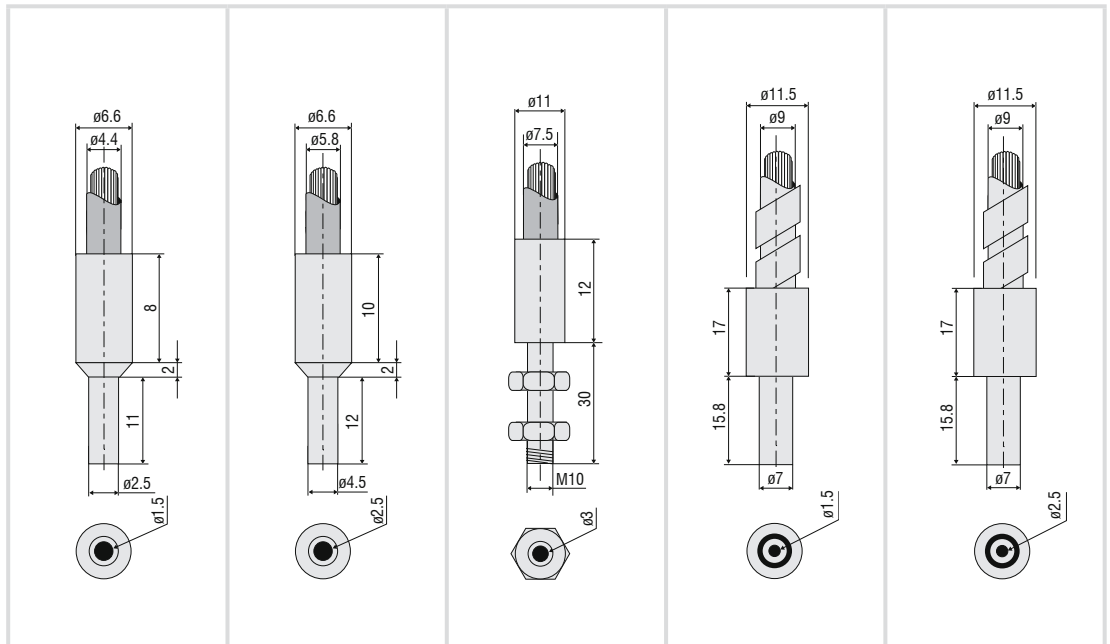

Model	CFS3-A11	CFS3-A20	CFS3-C30	CFS3-M12-600	CFS3-M20-M	
Article number	10810518	10810490	10811921	10810353	10810438	
Sensor type	Transmission sensor					
Operating range (transmitter-receiver distance)	Start	1 mm				
	End	500 mm	1700 mm	2000 mm	90 mm	200 mm
Working distance (measuring object - receiver)	Measuring object can be freely positioned between transmitter and receiver					
Measurement geometry	0°:180°					
Min. target size ¹⁾	Ø0.1 µm	Ø0.2 µm	Ø0.3 µm	Ø0.05 µm	Ø0.1 µm	
Connection	Screwable fiber optic cable via FA socket (M18x1),					
	Standard length 1.2 m; max. bending radius 13.2 mm	Standard length 1.2 m; max. bending radius 17.4 mm	Standard length 1.2 m; max. bending radius 22.5 mm	Length 0.6 m; max. bending radius 13.2 mm	Standard length 1.2 m; max. bending radius 15 mm	
Mounting	FA (M18x1)					
Temperature range	Storage	Sensor head: -10 ... +80 °C; Optical fiber: -60 ... +180 °C			Sensor head: -10 ... +80 °C Fiber optic cable: -40 ... +300 °C	
	Operation					
Humidity (non-condensing)	20 ... 80 % RH				20 ... 60 % RH	
Protection class (DIN EN 60529)	IP64				IP40	
Sensor head	Stainless steel					
Material	Optical fibers	integrated glass fiber (Ø1.5 mm) and metal- silicone (T) sheathing	integrated glass fiber (Ø2.5 mm) and metal- silicone (T) sheathing	integrated glass fiber (Ø3.0 mm) and metal- silicone (T) sheathing	integrated glass fiber (Ø0.6 mm) and metal- silicone (T) sheathing	integrated glass fiber (Ø1.0 mm) and brass spiral hose chrome- plated (M)
Weight	90 g	160 g	280 g	48 g	100 g	
Compatibility	compatible with all CLS and CFO controllers					
Special features	All variants are also available with different sheath, length 0.3 ... 10 m, vibration protection, IP protection, suitable for drag chains and available for temperature ranges up to 2000 °C. In combination with a pressure-tight feedthrough, a stainless steel sheath and T250° bonding, vacuum applications down to 10 ⁻⁶ mbar are also possible.					

¹⁾ These values apply over the entire operating range. Except the middle of the distance between the transmitter and receiver

Standard sensor types for individual configuration

Optical glass fibers

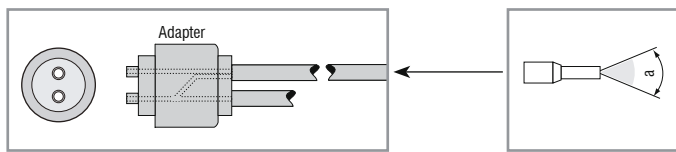

Fiber optics types CFS3 or CFS4

+

Ferrule

The end ferrule gives the fiber optic bundle its defined measurement geometry, e.g., as a point or line. This also enables 90° deflections or defines the mechanical fastening (screw connection, clamping, integrated thread).

A Type A ferrule, stainless steel

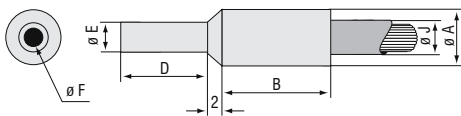

Ø F	Type	Ø A	B	D	Ø E	P	Ø J M	T
1.5	A10	4.6	8	11	2.5	4	4	-
1.5	A11	6.6	8	11	2.5	-	5	4.4
2.5	A20	6.6	10	12	4.5	6	6	5.8
3	A30	8.5	11	15	6	7	7	7.5

D Type D ferrule, stainless steel

With angular probe heads, a reduction in range can be expected compared to axially emerging versions.

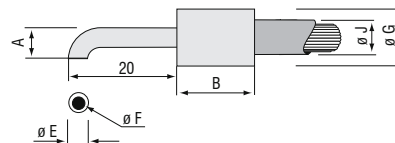

Ø F	Type	Ø A	B	Ø E	Ø G	r	P	Ø J M	T
0.6	D10/90	2.5	10	1	3	1.5	2	-	-
0.6	D11/90	2.5	13	1	6	1.5	-	-	4.4
1.5	D20/90	6	13	2	6	4	5	5	4.4
2.5	D30/90	15	17	5	9	10	7	7	6.5

* D10/90 only suitable for PVC sheath

B Type B ferrule

(only suitable for PVC sheath)

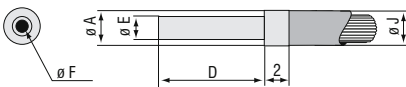

Ø F	Type	Ø A	D	Ø E	Ø J P	Ferrule
0.6	B11	2	30	1	2	Stainless steel
0.6	B12	2	10	1	2	Stainless steel
1	B20	3	10	2	3	Alu
2.5	B30	5	12	4	5	Alu
3	B40	8	12	6	8	Alu

E Type E ferrule, stainless steel

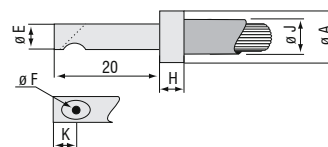

Ø F	Type	Ø A	Ø E	H	K	P	Ø J M	T
1.5	E10/90	4	3	1.5	4	4	-	-
2.5	E20/90	5	4	1.5	4	5	5	-
2.5	E21/90	7	4	10	4	-	-	5.8
3	E30/90	8	6	1.5	5	7	7	-

* E10/90 only suitable for PVC sheathing

C Type C ferrule, stainless steel

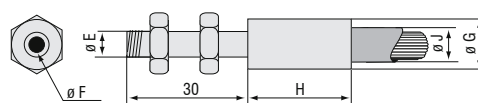

Ø F	Type	E	Ø G	H	P	Ø J M	T
1.0	C10	M4	6	13	5	5	4.4
2.5	C20	M6	8	15	6	6	5.8
3	C30	M10	11	12	7	7	7.5

F Type F ferrule, stainless steel

With angular probe heads, a reduction in range can be expected compared to axially emerging versions.

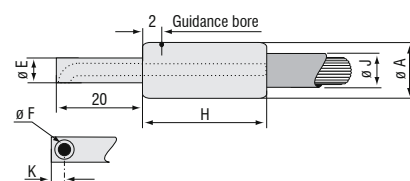

Ø F	Type	Ø A	Ø E	H	K	P	Ø J M	T
1.5	F10/90	8	6	9	3	5	5	5.8
2.5	F20/90	10	8	10	4	6	6	6.5
3	F30/90	12	10	10	5	7	7	7.5

M Ferrule type M, aluminum / stainless steel

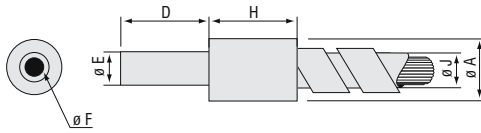

Ø F	Type	Ø A	D	Ø E	H	Ø J		Ferrule
						M	T	
0.6	M11	6	30	1	10	5	4.4	Stainless steel
0.6	M12	6	10	1	10	5	4.4	Stainless steel
1	M20	6	10	2	10	5	4.4	Alu
2.5	M30	7	12	4	12	6	5.8	Alu
3.5	M40	9	12	6	12	7	7.5	Alu
5	M50	12	16	7	16	9	9	Alu
6	M60	13	16	8	18	10	11.5	Alu
8	M80	16	20	10	20	13	13.5	Alu
10	M100	18	20	12	20	15	-	Alu

Larger fiber cross-sections possible

Q Type Q, aluminum

Also available in stainless steel

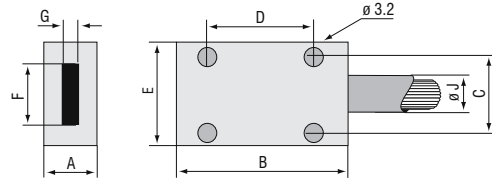

F	G	Type	A	B	C	D	E	Ø J
5	0.5	Q1	12	25	9	15	15	depends on fiber cross-section
10	0.3	Q2	12	30	14	20	20	
18	0.3	Q3	12	35	24	25	30	
28	0.2	Q4	12	55	34	40	40	
38	0.15	Q5	12	55	44	40	50	
48	0.15	Q6	12	55	54	40	60	
58	*	Q7	16	75	64	60	70	
68	*	Q8	16	75	74	60	80	
78	*	Q9	20	90	84	75	90	
88	*	Q10	20	90	94	75	100	

FxG max. 9.62 mm²; F=3.5 mm as special variant
Q7 to Q10 only available as FAR special model

N End sleeve type N, aluminum

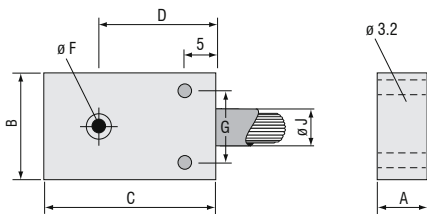

F	Type	A	B	C	D	G	P	Ø J	M	T
0.6	N10/90	6	15	25	20	9	4	5	4.4	
1.5	N21/90	8	18	25	20	11	5	5	5.8	
2.5	N31/90	12	20	25	20	13	6	6	6.5	

R Type R ferrule, aluminum

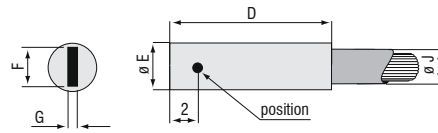

F	G max.	Type	D	Ø E	P	Ø J	M	T
3	0.5	R10*	25	4	3	-	-	
3	0.5	R11	30	7	6	6	5.8	
6	1	R20	25	7	6	-	-	
6	1	R21	30	10	-	7	7.5	

* R10 and R20 only suitable for PVC sheath

O Type O ferrule, bendable to a certain extent

With angular probe heads, a reduction in range can be expected compared to axially emerging versions.

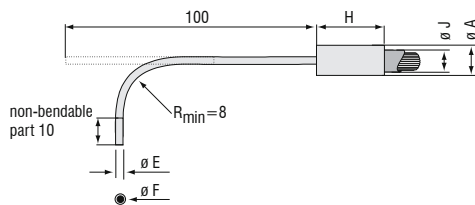

Ø F	Type	Ø A	Ø E	H	P	Ø J	M	T
0.6	O10	2	1	10	2	-	-	
0.6	O11	7	1	20	-	5	4.4	
1	O20	3	1.3	10	3	-	-	
1	O21	7	1.3	20	-	5	4.4	

P Type P ferrule, aluminum

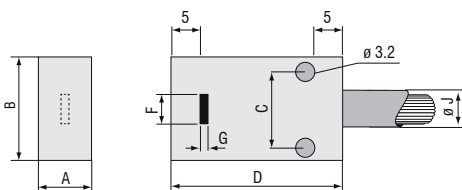

F	G	Type	A	B	C	D	P	Ø J	M	T
3	0.1	P10/90	8	15	9	25	4	5	4.4	
6	0.3	P21/90	8	17	11	30	4	6	6.5	
10	0.5	P31/90	12	17	11	30	6	6	6.5	

Extensions / feedthrough

For extension or feedthrough of the optical fibers please use the Type LV ferrule.

LV Type LV ferrule

Fiber optic extension / feedthrough

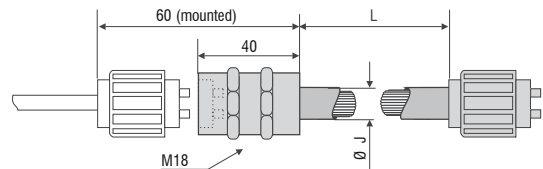

Fiber bundle Ø	P	Ø J	M	T	L
(3 mm) / channel	12	13	13.5	variable	

Sensors and Systems from Micro-Epsilon



Sensors and systems for displacement, distance and position



Sensors and measurement devices for non-contact temperature measurement

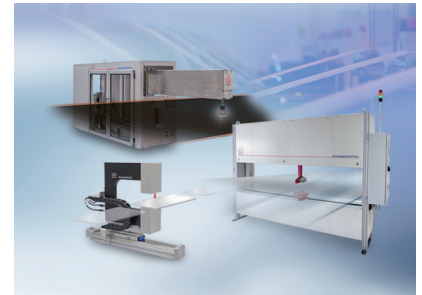

Measuring and inspection systems for metal strips, plastics and rubber



Optical micrometers and fiber optics, measuring and test amplifiers



Color recognition sensors, LED analyzers and inline color spectrometers

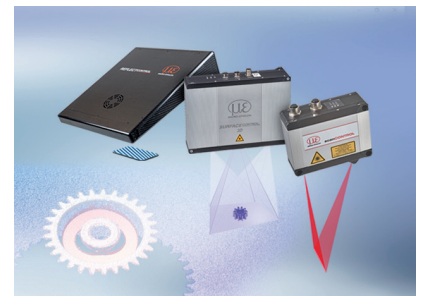

3D measurement technology for dimensional testing and surface inspection